

**JOHN DEERE**  
**WORLDWIDE COMMERCIAL & CONSUMER**  
**EQUIPMENT DIVISION**

---

**Gator Utility Vehicles**  
**4X2 and 4X6**

TM1518 SEPTEMBER 2004

**TECHNICAL MANUAL**



**JOHN DEERE**

North American Version  
Litho in U.S.A.



# INTRODUCTION

## Manual Description

This technical manual is written for an experienced technician and contains sections that are specifically for this product. It is a part of a total product support program.

The manual is organized so that all the information on a particular system is kept together. The order of grouping is as follows:

- Table of Contents
- Specifications and Information
- Identification Numbers
- Tools and Materials
- Component Location
- Schematics and Harnesses
- Theory of Operation
- Operation and Diagnostics
- Diagnostics
- Tests and Adjustments
- Repair
- Other

**NOTE: Depending on the particular section or system being covered, not all of the above groups may be used.**

The bleed tabs for the pages of each section will align with the sections listed on this page. Page numbering is consecutive from the beginning of the Safety section through the last section.

We appreciate your input on this manual. If you find any errors or want to comment on the layout of the manual please contact us.

Safety

Specifications and Information

Engine - Gas (Air-Cooled)

Engine - Gas (Liquid-Cooled)

Engine - Diesel

Electrical

Power Train - Gear

Steering

Brakes

Attachments

Engine - Rotary Broom

Miscellaneous

All information, illustrations and specifications in this manual are based on the latest information at the time of publication. The right is reserved to make changes at any time without notice.

COPYRIGHT© 2004  
Deere & Co.

John Deere Worldwide Commercial and  
Consumer Equipment Division  
All rights reserved  
Previous Editions  
COPYRIGHT© 2001, 2002, 2004

**Thanks very much for your reading,  
Want to get more information,  
Please click here, Then get the complete  
manual**

**JustClickHere** 

**NOTE:**

**If there is no response to click on the link above,  
please download the PDF document first, and then  
click on it.**

**Have any questions please write to me:  
[admin@servicemanualperfect.com](mailto:admin@servicemanualperfect.com)**



# SAFETY

## Recognize Safety Information

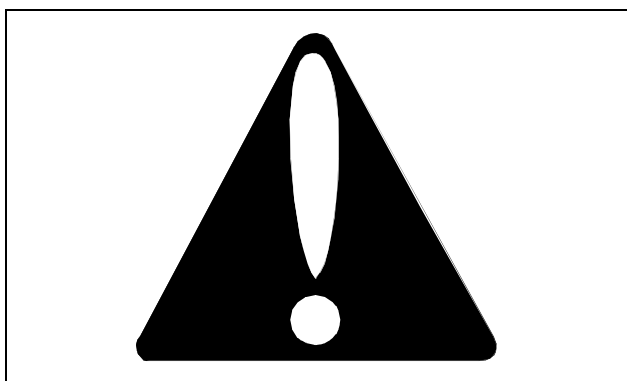

MIF

This is the safety-alert symbol. When you see this symbol on your machine or in this manual, be alert to the potential for personal injury.

Follow recommended precautions and safe servicing practices.

## Understand Signal Words

A signal word - DANGER, WARNING, or CAUTION - is used with the safety-alert symbol. DANGER identifies the most serious hazards.

DANGER or WARNING safety signs are located near specific hazards. General precautions are listed on CAUTION safety signs. CAUTION also calls attention to safety messages in this manual.

## Replace Safety Signs

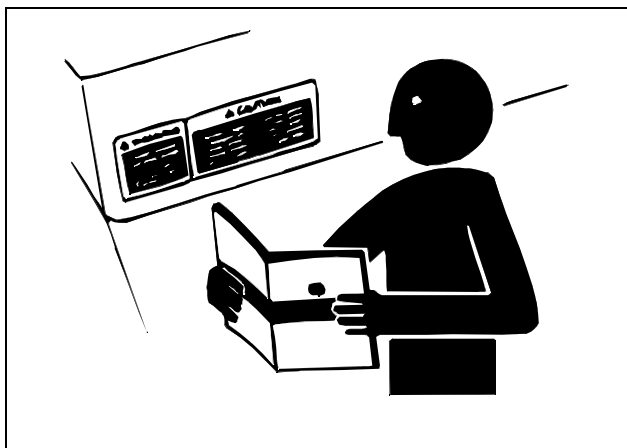

MIF

Replace missing or damaged safety signs. See the machine operator's manual for correct safety sign placement.

## Handle Fluids Safely - Avoid Fires

### Be Prepared For Emergencies

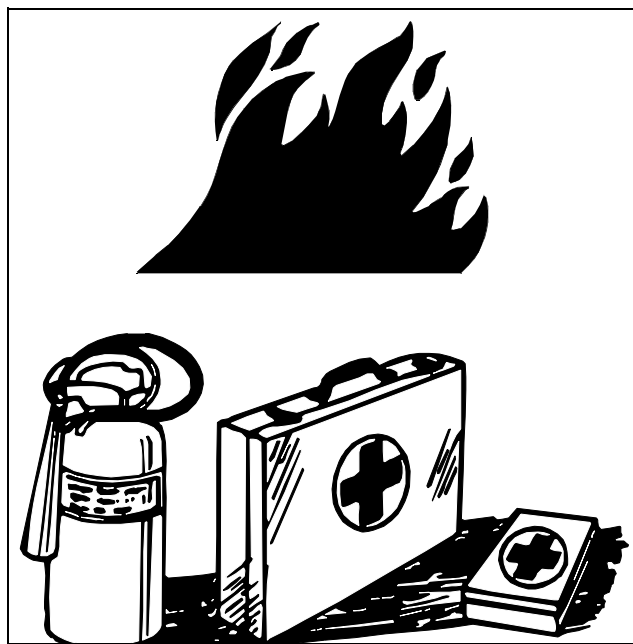

MIF

- When you work around fuel, do not smoke or work near heaters or other fire hazards.
- Store flammable fluids away from fire hazards. Do not incinerate or puncture pressurized containers.
- Make sure machine is clean of trash, grease, and debris.
- Do not store oily rags; they can ignite and burn spontaneously.
- Be prepared if a fire starts.
- Keep a first aid kit and fire extinguisher handy.
- Keep emergency numbers for doctors, ambulance service, hospital, and fire department near your telephone.

## Use Care In Handling and Servicing Batteries

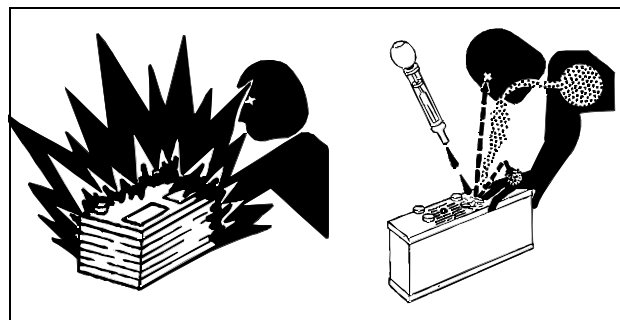

MIF

# SAFETY

## Prevent Battery Explosions

- Keep sparks, lighted matches, and open flame away from the top of battery. Battery gas can explode.
- Never check battery charge by placing a metal object across the posts. Use a volt-meter or hydrometer.
- Do not charge a frozen battery; it may explode. Warm battery to 16°C (60°F).

## Prevent Acid Burns

- Sulfuric acid in battery electrolyte is poisonous. It is strong enough to burn skin, eat holes in clothing, and cause blindness if splashed into eyes.

### Avoid acid burns by:

1. Filling batteries in a well-ventilated area.
2. Wearing eye protection and rubber gloves.
3. Avoiding breathing fumes when electrolyte is added.
4. Avoiding spilling or dripping electrolyte.
5. Use proper jump start procedure.

### If you spill acid on yourself:

1. Flush your skin with water.
2. Apply baking soda or lime to help neutralize the acid.
3. Flush your eyes with water for 10 - 15 minutes.
4. Get medical attention immediately.

### If acid is swallowed:

1. Drink large amounts of water or milk.
2. Then drink milk of magnesia, beaten eggs, or vegetable oil.
3. Get medical attention immediately.

## Wear Protective Clothing

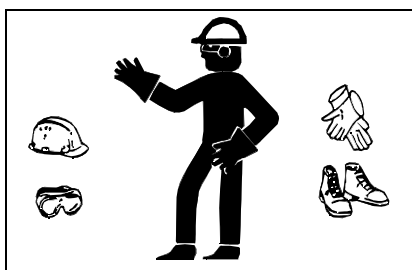

MIF

Wear close fitting clothing and safety equipment appropriate to the job.

Prolonged exposure to loud noise can cause impairment or loss of hearing. Wear a suitable hearing protective device

such as earmuffs or earplugs to protect against objectionable or uncomfortable loud noises.

Operating equipment safely requires the full attention of the operator. Do not wear radio or music headphones while operating machine.

## Use Care Around High-pressure Fluid Lines

### Avoid High-Pressure Fluids



MIF

Escaping fluid under pressure can penetrate the skin causing serious injury.

Avoid injury from escaping fluid under pressure by stopping the engine and relieving pressure in the system before disconnecting or connecting hydraulic or other lines. Tighten all connections before applying pressure.

Search for leaks with a piece of cardboard. Protect hands and body from high pressure fluids.

If an accident occurs, see a doctor immediately. Any fluid injected into the skin must be surgically removed within a few hours or gangrene may result. Doctors unfamiliar with this type of injury should reference a knowledgeable medical source. Such information is available from Deere & Company Medical Department in Moline, Illinois, U.S.A.

### Avoid Heating Near Pressurized Fluid Lines



MIF

Flammable spray can be generated by heating near pressurized fluid lines, resulting in severe burns to yourself and bystanders. Do not heat by welding, soldering, or using a torch near pressurized fluid lines or other flammable materials. Pressurized lines can be accidentally cut when heat goes beyond the immediate flame area.

# SAFETY

## Service Machines Safely

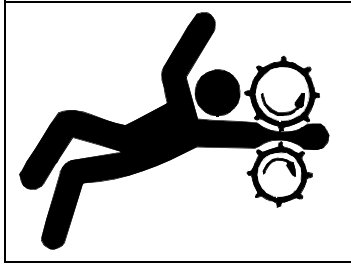

MIF

Tie long hair behind your head. Do not wear a necktie, scarf, loose clothing, or necklace when you work near machine tools or moving parts. If these items were to get caught, severe injury could result.

Remove rings and other jewelry to prevent electrical shorts and entanglement in moving parts.

## Use Proper Tools

Use tools appropriate to the work. Makeshift tools and procedures can create safety hazards. Use power tools only to loosen threaded parts and fasteners. For loosening and tightening hardware, use the correct size tools. **DO NOT** use U.S. measurement tools on metric fasteners. Avoid bodily injury caused by slipping wrenches. Use only service parts meeting John Deere specifications.

## Park Machine Safely

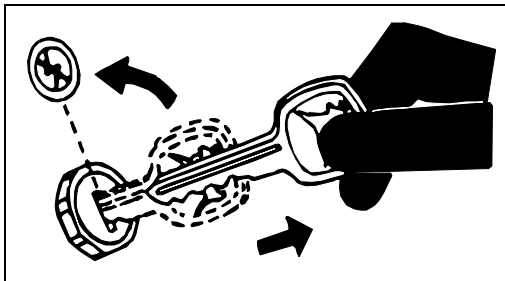

MIF

### Before working on the machine:

1. Lower all equipment to the ground.
2. Stop the engine and remove the key.
3. Disconnect the battery ground strap.
4. Hang a "DO NOT OPERATE" tag in operator station.

## Support Machine Properly and Use Proper Lifting Equipment

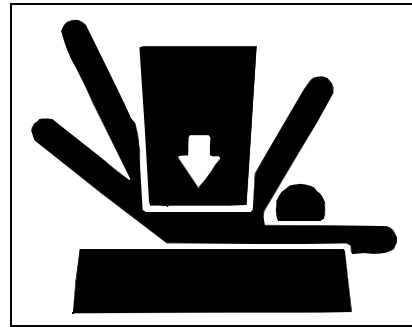

MIF

If you must work on a lifted machine or attachment, securely support the machine or attachment.

Do not support the machine on cinder blocks, hollow tiles, or props that may crumble under continuous load. Do not work under a machine that is supported solely by a jack. Follow recommended procedures in this manual.

Lifting heavy components incorrectly can cause severe injury or machine damage. Follow recommended procedure for removal and installation of components in the manual.

## Work In Clean Area

### Before starting a job:

1. Clean work area and machine.
2. Make sure you have all necessary tools to do your job.
3. Have the right parts on hand.
4. Read all instructions thoroughly; do not attempt shortcuts.

## Using High Pressure Washers

Directing pressurized water at electronic/electrical components or connectors, bearings, hydraulic seals, fuel injection pumps or other sensitive parts and components may cause product malfunctions. Reduce pressure and spray at a 45 to 90 degree angle.

## Illuminate Work Area Safely

Illuminate your work area adequately but safely. Use a portable safety light for working inside or under the machine. Make sure the bulb is enclosed by a wire cage. The hot filament of an accidentally broken bulb can ignite spilled fuel or oil.



# SAFETY

## Work In Ventilated Area

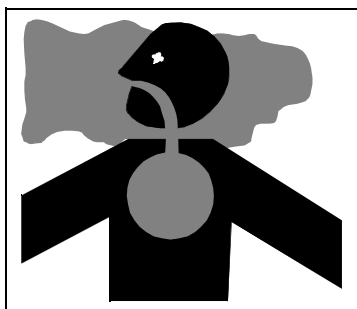

MIF

Engine exhaust fumes can cause sickness or death. If it is necessary to run an engine in an enclosed area, remove the exhaust fumes from the area with an exhaust pipe extension.

If you do not have an exhaust pipe extension, open the doors and get outside air into the area.

## Warning: California Proposition 65 Warning

Gasoline engine exhaust from this product contains chemicals known to the State of California to cause cancer, birth defects, or other reproductive harm.

Diesel engine exhaust and some of its constituents are known to the State of California to cause cancer, birth defects, and other reproductive harm.

## Remove Paint Before Welding or Heating

Avoid potentially toxic fumes and dust. Hazardous fumes can be generated when paint is heated by welding, soldering, or using a torch. Do all work outside or in a well ventilated area. Dispose of paint and solvent properly. Remove paint before welding or heating: If you sand or grind paint, avoid breathing the dust. Wear an approved respirator. If you use solvent or paint stripper, remove stripper with soap and water before welding. Remove solvent or paint stripper containers and other flammable material from area. Allow fumes to disperse at least 15 minutes before welding or heating.

## Avoid Harmful Asbestos Dust

Avoid breathing dust that may be generated when handling components containing asbestos fibers. Inhaled asbestos fibers may cause lung cancer.

Components in products that may contain asbestos fibers are brake pads, brake band and lining assemblies, clutch plates, and some gaskets. The asbestos used in these components is usually found in a resin or sealed in some way. Normal handling is not hazardous as long as airborne dust containing asbestos is not generated.

Avoid creating dust. Never use compressed air for cleaning. Avoid brushing or grinding material containing asbestos. When servicing, wear an approved respirator. A special vacuum cleaner is recommended to clean asbestos. If not available, apply a mist of oil or water on the material containing asbestos. Keep bystanders away from the area.

## Service Tires Safely

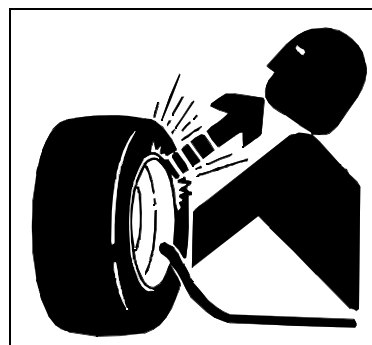

MIF

Explosive separation of a tire and rim parts can cause serious injury or death.

Do not attempt to mount a tire unless you have the proper equipment and experience to perform the job.

Always maintain the correct tire pressure. Do not inflate the tires above the recommended pressure. Never weld or heat a wheel and tire assembly. The heat can cause an increase in air pressure resulting in a tire explosion. Welding can structurally weaken or deform the wheel.

When inflating tires, use a clip-on chuck and extension hose long enough to allow you to stand to one side and NOT in front of or over the tire assembly. Use a safety cage if available.

Check wheels for low pressure, cuts, bubbles, damaged rims or missing lug bolts and nuts.

# SAFETY

## Avoid Injury From Rotating Blades, Augers and PTO Shafts

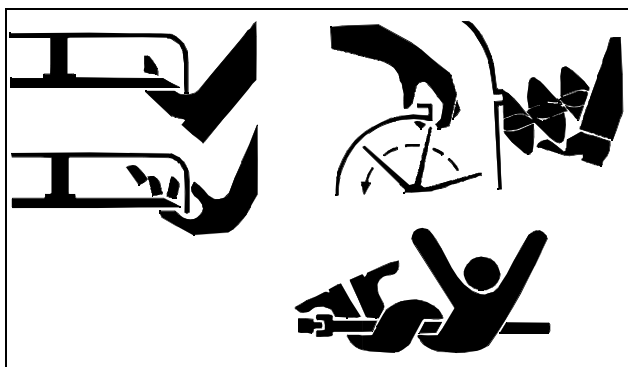

MIF

Keep hands and feet away while machine is running. Shut off power to service, lubricate or remove mower blades, augers or PTO shafts.

## Service Cooling System Safely

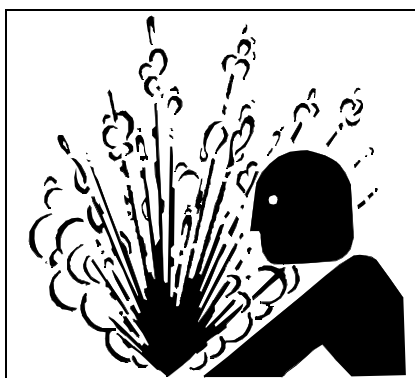

MIF

Explosive release of fluids from pressurized cooling system can cause serious burns.

Shut off machine. Only remove filler cap when cool enough to touch with bare hands. Slowly loosen cap to first stop to relieve pressure before removing completely.

## Handle Chemical Products Safely

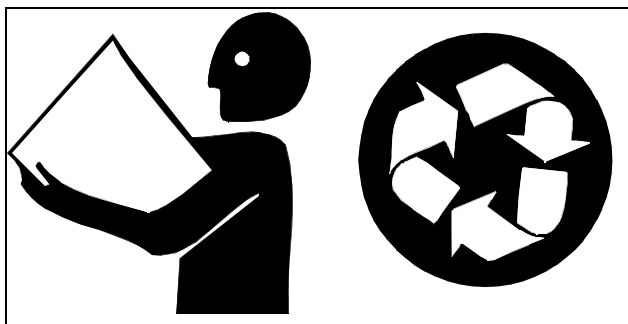

MIF

Direct exposure to hazardous chemicals can cause serious injury. Potentially hazardous chemicals used with John Deere equipment include such items as lubricants, coolants, paints, and adhesives.

A Material Safety Data Sheet (MSDS) provides specific details on chemical products: physical and health hazards, safety procedures, and emergency response techniques. Check the MSDS before you start any job using a hazardous chemical. That way you will know exactly what the risks are and how to do the job safely. Then follow procedures and recommended equipment.

## Dispose of Waste Properly

Improperly disposing of waste can threaten the environment and ecology. Potentially harmful waste used with John Deere equipment include such items as oil, fuel, coolant, brake fluid, filters, and batteries. Use leakproof containers when draining fluids. Do not use food or beverage containers that may mislead someone into drinking from them. Do not pour waste onto the ground, down a drain, or into any water source. Inquire on the proper way to recycle or dispose of waste from your local environmental or recycling center, or from your John Deere dealer.

## Live With Safety



MIF

Before returning machine to customer, make sure machine is functioning properly, especially the safety systems. Install all guards and shields.

# SAFETY

---

---

# SPECIFICATIONS & INFORMATION TABLE OF CONTENTS

---

## Table of Contents

|                                                  |           |
|--------------------------------------------------|-----------|
| <b>Fastener Torques</b> .....                    | <b>9</b>  |
| Metric Fastener Torque Values .....              | 9         |
| Inch Fastener Torque Values .....                | 10        |
| <b>O-Ring Seal Service Recommendations</b> ..... | <b>11</b> |
| Face Seal Fittings                               |           |
| With Inch Stud Ends Torque .....                 | 11        |
| Face Seal Fittings                               |           |
| With Metric Stud Ends Torque .....               | 12        |
| O-Ring Face Seal Fittings .....                  | 13        |
| O-Ring Boss Fittings .....                       | 13        |
| Straight Fitting Or Special Nut Torques.....     | 13        |
| Metric Fastener Torque Value -                   |           |
| Grade 7 (Special) .....                          | 14        |
| <b>General Information</b> .....                 | <b>14</b> |
| Gasoline .....                                   | 14        |
| Gasoline Storage.....                            | 15        |
| 4 - Cycle Gasoline Engine Oil .....              | 15        |
| Diesel Fuel .....                                | 16        |
| Diesel Fuel Lubricity .....                      | 16        |
| Diesel Fuel Storage.....                         | 16        |
| Break-In Engine Oil - 4-Cycle Gasoline.....      | 16        |
| 4 - Cycle Diesel Engine Oil.....                 | 17        |
| Break-In Engine Oil - Diesel .....               | 17        |
| Hydrostatic Transmission                         |           |
| and Hydraulic Oil.....                           | 18        |
| Gear Case Oil.....                               | 19        |
| Gear Transmission Grease .....                   | 19        |
| Alternative Lubricants.....                      | 19        |
| Synthetic Lubricants .....                       | 20        |
| Lubricant Storage .....                          | 20        |
| Mixing of Lubricants .....                       | 20        |
| Oil Filters .....                                | 20        |
| <b>Coolant Specifications</b> .....              | <b>20</b> |
| Gasoline Engine Coolant.....                     | 20        |
| Gasoline Engine Coolant Drain Interval .....     | 21        |
| Diesel Engine Coolant.....                       | 21        |
| Diesel Engine Coolant Drain Interval .....       | 22        |
| <b>Serial Number Locations</b> .....             | <b>22</b> |
| Product Serial Number .....                      | 22        |
| Engine (FE290D) Serial Number Location ..        | 22        |
| Engine (FE620D) Serial Number Location ..        | 23        |
| Engine (3TN66C) Serial Number Location...        | 23        |
| Transaxle Serial Number Location .....           | 23        |

# **SPECIFICATIONS & INFORMATION TABLE OF CONTENTS**

---

---



# SPECIFICATIONS & INFORMATION FASTENER TORQUES

## Fastener Torques

### Metric Fastener Torque Values

|                                         |  |  |  |  |
|-----------------------------------------|--|--|--|--|
| <b>Property Class and Head Markings</b> |  |  |  |  |
| <b>Property Class and Nut Markings</b>  |  |  |  |  |

MIF

| SIZE | Class 4.8    |       | Class 8.8 or 9.8 |       |              |       | Class 10.9 |       |              |       | Class 12.9 |       |              |       |       |       |
|------|--------------|-------|------------------|-------|--------------|-------|------------|-------|--------------|-------|------------|-------|--------------|-------|-------|-------|
|      | Lubricated a |       | Dry a            |       | Lubricated a |       | Dry a      |       | Lubricated a |       | Dry a      |       | Lubricated a |       | Dry a |       |
|      | N•m          | lb-ft | N•m              | lb-ft | N•m          | lb-ft | N•m        | lb-ft | N•m          | lb-ft | N•m        | lb-ft | N•m          | lb-ft | N•m   | lb-ft |
| M6   | 4.8          | 3.5   | 6                | 4.5   | 9            | 6.5   | 11         | 8.5   | 13           | 9.5   | 17         | 12    | 15           | 11.5  | 19    | 14.5  |
| M8   | 12           | 8.5   | 15               | 11    | 22           | 16    | 28         | 20    | 32           | 24    | 40         | 30    | 37           | 28    | 47    | 35    |
| M10  | 23           | 17    | 29               | 21    | 43           | 32    | 55         | 40    | 63           | 47    | 80         | 60    | 75           | 55    | 95    | 70    |
| M12  | 40           | 29    | 50               | 37    | 75           | 55    | 95         | 70    | 110          | 80    | 140        | 105   | 130          | 95    | 165   | 120   |
| M14  | 63           | 47    | 80               | 60    | 120          | 88    | 150        | 110   | 175          | 130   | 225        | 165   | 205          | 150   | 260   | 109   |
| M16  | 100          | 73    | 125              | 92    | 190          | 140   | 240        | 175   | 275          | 200   | 350        | 225   | 320          | 240   | 400   | 300   |
| M18  | 135          | 100   | 175              | 125   | 260          | 195   | 330        | 250   | 375          | 275   | 475        | 350   | 440          | 325   | 560   | 410   |
| M20  | 190          | 140   | 240              | 180   | 375          | 275   | 475        | 350   | 530          | 400   | 675        | 500   | 625          | 460   | 800   | 580   |
| M22  | 260          | 190   | 330              | 250   | 510          | 375   | 650        | 475   | 725          | 540   | 925        | 675   | 850          | 625   | 1075  | 800   |
| M24  | 330          | 250   | 425              | 310   | 650          | 475   | 825        | 600   | 925          | 675   | 1150       | 850   | 1075         | 800   | 1350  | 1000  |
| M27  | 490          | 360   | 625              | 450   | 950          | 700   | 1200       | 875   | 1350         | 1000  | 1700       | 1250  | 1600         | 1150  | 2000  | 1500  |
| M30  | 675          | 490   | 850              | 625   | 1300         | 950   | 1650       | 1200  | 1850         | 1350  | 2300       | 1700  | 2150         | 1600  | 2700  | 2000  |
| M33  | 900          | 675   | 1150             | 850   | 1750         | 1300  | 2200       | 1650  | 2500         | 1850  | 3150       | 2350  | 2900         | 2150  | 3700  | 2750  |
| M36  | 1150         | 850   | 1450             | 1075  | 2250         | 1650  | 2850       | 2100  | 3200         | 2350  | 4050       | 3000  | 3750         | 2750  | 4750  | 3500  |

DO NOT use these hand torque values if a different torque value or tightening procedure is given for a specific application. Torque values listed are for general use only and include a ±10% variance factor. Check tightness of fasteners periodically. DO NOT use air powered wrenches.

Shear bolts are designed to fail under predetermined loads. Always replace shear bolts with identical grade.

Fasteners should be replaced with the same grade. Make sure fastener threads are clean and that you properly start thread engagement. This will prevent them from failing when tightening.

When bolt and nut combination fasteners are used, torque values should be applied to the NUT instead of the bolt head.









Tighten toothed or serrated-type lock nuts to the full torque value.

a "Lubricated" means coated with a lubricant such as engine oil, or fasteners with phosphate and oil coatings. "Dry" means plain or zinc plated (yellow dichromate - Specification JDS117) without any lubrication.

Reference: JDS - G200.

# SPECIFICATIONS & INFORMATION FASTENER TORQUES

## Inch Fastener Torque Values

|                                    |                                                                                                                   |                                                                                                                                                                            |                                                                                                                                                                              |
|------------------------------------|-------------------------------------------------------------------------------------------------------------------|----------------------------------------------------------------------------------------------------------------------------------------------------------------------------|------------------------------------------------------------------------------------------------------------------------------------------------------------------------------|
| <b>SAE Grade and Head Markings</b> | 1 or 2 <sup>b</sup><br>No Marks  | 5    5.1    5.2<br>                                                                      | 8    8.2<br>                                                                              |
| <b>SAE Grade and Nut Markings</b>  | 2<br>No Marks                    | 5<br>  | 8<br>  |

MIF

| SIZE  | Grade 1      |       | Grade 2b |       |              |       | Grade 5, 5.1 or 5.2 |       |              |       | Grade 8 or 8.2 |       |              |       |       |       |
|-------|--------------|-------|----------|-------|--------------|-------|---------------------|-------|--------------|-------|----------------|-------|--------------|-------|-------|-------|
|       | Lubricated a |       | Dry a    |       | Lubricated a |       | Dry a               |       | Lubricated a |       | Dry a          |       | Lubricated a |       | Dry a |       |
|       | N•m          | lb-ft | N•m      | lb-ft | N•m          | lb-ft | N•m                 | lb-ft | N•m          | lb-ft | N•m            | lb-ft | N•m          | lb-ft | N•m   | lb-ft |
| 1/4   | 3.7          | 2.8   | 4.7      | 3.5   | 6            | 4.5   | 7.5                 | 5.5   | 9.5          | 7     | 12             | 9     | 13.5         | 10    | 17    | 12.5  |
| 5/16  | 7.7          | 5.5   | 10       | 7     | 12           | 9     | 15                  | 11    | 20           | 15    | 25             | 18    | 28           | 21    | 35    | 26    |
| 3/8   | 14           | 10    | 17       | 13    | 22           | 16    | 27                  | 20    | 35           | 26    | 44             | 33    | 50           | 36    | 63    | 46    |
| 7/16  | 22           | 16    | 28       | 20    | 35           | 26    | 44                  | 32    | 55           | 41    | 70             | 52    | 80           | 58    | 100   | 75    |
| 1/2   | 33           | 25    | 42       | 31    | 53           | 39    | 67                  | 50    | 85           | 63    | 110            | 80    | 120          | 90    | 150   | 115   |
| 9/16  | 48           | 36    | 60       | 45    | 75           | 56    | 95                  | 70    | 125          | 90    | 155            | 115   | 175          | 130   | 225   | 160   |
| 5/8   | 67           | 50    | 85       | 62    | 105          | 78    | 135                 | 100   | 170          | 125   | 215            | 160   | 215          | 160   | 300   | 225   |
| 3/4   | 120          | 87    | 150      | 110   | 190          | 140   | 240                 | 175   | 300          | 225   | 375            | 280   | 425          | 310   | 550   | 400   |
| 7/8   | 190          | 140   | 240      | 175   | 190          | 140   | 240                 | 175   | 490          | 360   | 625            | 450   | 700          | 500   | 875   | 650   |
| 1     | 290          | 210   | 360      | 270   | 290          | 210   | 360                 | 270   | 725          | 540   | 925            | 675   | 1050         | 750   | 1300  | 975   |
| 1-1/8 | 470          | 300   | 510      | 375   | 470          | 300   | 510                 | 375   | 900          | 675   | 1150           | 850   | 1450         | 1075  | 1850  | 1350  |
| 1-1/4 | 570          | 425   | 725      | 530   | 570          | 425   | 725                 | 530   | 1300         | 950   | 1650           | 1200  | 2050         | 1500  | 2600  | 1950  |
| 1-3/8 | 750          | 550   | 950      | 700   | 750          | 550   | 950                 | 700   | 1700         | 1250  | 2150           | 1550  | 2700         | 2000  | 3400  | 2550  |
| 1-1/2 | 1000         | 725   | 1250     | 925   | 990          | 725   | 1250                | 930   | 2250         | 1650  | 2850           | 2100  | 3600         | 2650  | 4550  | 3350  |

DO NOT use these hand torque values if a different torque value or tightening procedure is given for a specific application. Torque values listed are for general use only and include a ±10% variance factor. Check tightness of fasteners periodically. DO NOT use air powered wrenches.

Shear bolts are designed to fail under predetermined loads. Always replace shear bolts with identical grade.

Fasteners should be replaced with the same grade. Make sure fastener threads are clean and that you properly start thread engagement. This will prevent them from failing when tightening.

When bolt and nut combination fasteners are used, torque values should be applied to the NUT instead of the bolt

head.

Tighten toothed or serrated-type lock nuts to the full torque value.

a "Lubricated" means coated with a lubricant such as engine oil, or fasteners with phosphate and oil coatings.

"Dry" means plain or zinc plated (yellow dichromate - Specification JDS117) without any lubrication.

b "Grade 2" applies for hex cap screws (Not Hex Bolts) up to 152 mm (6 in.) long. "Grade 1" applies for hex cap screws over 152 mm (6 in.) long, and for all other types of bolts and screws of any length.

Reference: JDS - G200

# SPECIFICATIONS & INFORMATION O-RING SEAL SERVICE

## O-Ring Seal Service Recommendations

### Face Seal Fittings With Inch Stud Ends Torque

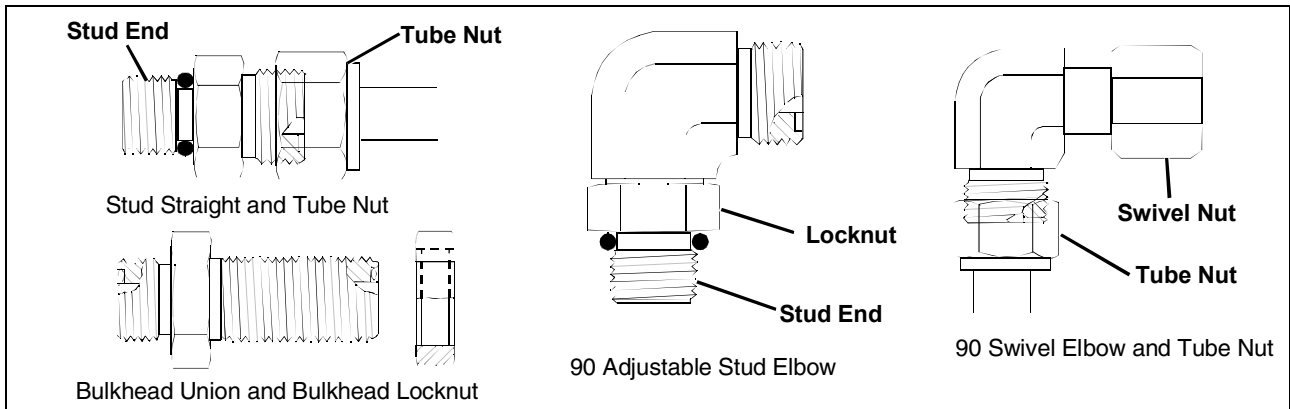

MIF

| Nominal Tube OD/Hose ID |              |           |       | Face Seal Tube/Hose End |                                   |     |                                |       | O-Ring Stud Ends |                                        |       |
|-------------------------|--------------|-----------|-------|-------------------------|-----------------------------------|-----|--------------------------------|-------|------------------|----------------------------------------|-------|
| Metric Tube OD          | Inch Tube OD |           |       | Thread Size             | Tube Nut/<br>Swivel Nut<br>Torque |     | Bulkhead<br>Lock Nut<br>Torque |       | Thread Size      | Straight Fitting or<br>Lock Nut Torque |       |
|                         | mm           | Dash Size | in.   |                         | mm                                | in. | N•m                            | lb-ft |                  | N•m                                    | lb-ft |
| 5                       | -3           | 0.188     | 4.76  |                         |                                   |     |                                |       | 3/8-24           | 8                                      | 6     |
| 6                       | -4           | 0.250     | 6.35  | 9/16-18                 | 16                                | 12  | 12                             | 9     | 7/16-20          | 12                                     | 9     |
| 8                       | -5           | 0.312     | 7.94  |                         |                                   |     |                                |       | 1/2-20           | 16                                     | 12    |
| 10                      | -6           | 0.375     | 9.52  | 11/16-16                | 24                                | 18  | 24                             | 18    | 9/16-18          | 24                                     | 18    |
| 12                      | -8           | 0.500     | 12.70 | 13/16-16                | 50                                | 37  | 46                             | 34    | 3/4-16           | 46                                     | 34    |
| 16                      | -10          | 0.625     | 15.88 | 1-14                    | 69                                | 51  | 62                             | 46    | 7/8-14           | 62                                     | 46    |
| 19                      | -12          | 0.750     | 19.05 | 1-3/16-12               | 102                               | 75  | 102                            | 75    | 1-1/16-12        | 102                                    | 75    |
| 22                      | -14          | 0.875     | 22.22 | 1-3/16-12               | 102                               | 75  | 102                            | 75    | 1-3/16-12        | 122                                    | 90    |
| 25                      | -16          | 1.000     | 25.40 | 1-7/16-12               | 142                               | 105 | 142                            | 105   | 1-5/16-12        | 142                                    | 105   |
| 32                      | -20          | 1.25      | 31.75 | 1-11/16-12              | 190                               | 140 | 190                            | 140   | 1-5/8-12         | 190                                    | 140   |
| 38                      | -24          | 1.50      | 38.10 | 2-12                    | 217                               | 160 | 217                            | 160   | 1-7/8-12         | 217                                    | 160   |

**NOTE: Torque tolerance is +15%, -20%**